



Instruction manual



2026-05-28

**Rack conveyor dishwasher 270 racks/
hour cold water, right exit
A 270 ABT RX M W Y**

www.rmgastro.com



TABLE OF CONTENTS

1. DECLARATION OF CONFORMITY	3
2. TECHNICAL DATA	3
3. LOCATION ELECTRIC	3
4. SAFETY MEASURES FOR FIRE PROTECTION	3
5. INSTALLATION	4
6. WATER CONNECTION	4
7. CONNECTING THE ELECTRICAL CABLE TO THE NETWORK	4
8. INSTRUCTIONS FOR USE	13
9. CLEANING AND MAINTENANCE	23

1. DECLARATION OF CONFORMITY

Decree of the Ministry of Health of the Czech Republic no. 38/2001 Coll. of 19 January 2001 Regulation (EC) No 1907/2006 - Registration, Evaluation, Authorisation and Restriction of Chemicals (REACH) Regulation of the European Parliament and Council Regulation (EC) no. 1935/2004 of 27 October 2004

The products meet the requirements of §26 of Act No.258/2000 as amended. The products meet the requirements of RoHS Directive 2015/863/EU, 10/2011, 517/2014, 2015/1094, 2015/1095.

Attention, the manufacturer gives up any responsibility in case of direct and indirect damage that is relate to poor installation, incorrect intervention or adjustments, insufficient maintenance, incorrect by using and which are eventually caused by other causes that the points referred to in the conditions sales. This appliance is intended only for professional use and must be operated by qualified by persons. Parts that have been secured by the manufacturer or authorized worker after the setting rebuild.

2. TECHNICAL DATA

The label with technical data is located on the side or back panel of the device. Please read the wiring diagram and all the following information in the attached manual before installation.

Net Width [mm]	Net Depth [mm]	Net Height [mm]	Net Weight [kg]
2519	1615	1615	383.00
Power electric [kW]	Loading	Basin volume [l]	
37.700	400 V / 3N - 50 Hz	70	

3. LOCATION ELECTRIC

For the correct operation and placement of the appliance, it is necessary to observe the following all prescribed standards for the given market. Unpack the device and check that the device has not been damaged during transport. Place the device on a horizontal surface (maximum unevenness up to 2°). Small unevenness can be leveled with adjustable feet. If the device will be placed in such a way that it will be in contact with the walls of the furniture, these must withstand a temperature of up to 60°C. Installation, adjustment, commissioning must be performed by a qualified person who is authorized to perform such operations, according to applicable standards. The device can be installed separately or in series with devices of our production. A minimum distance of 10 cm from flammable materials must be observed. In this case, it is necessary to secure the appropriate modifications to ensure the thermal insulation of the combustible parts. The appliance must only be installed on a non-flammable surface or against a non-flammable wall. **Parts of the appliance provided by the manufacturer. or his representative, the worker performing the installation may not rebuild the product.**

4. SAFETY MEASURES FOR FIRE PROTECTION

- the appliance may only be operated by adults
- the appliance may be used safely in accordance with applicable market standards:

Fire protection in spaces with special risk or danger

Protection against the effects of heat

- the appliance must be placed so that it stands or hangs firmly on a non-combustible surface

Objects of flammable substances must not be placed on the appliance at a distance less than a safe distance from it (the smallest distance between the appliance and flammable substances is 10 cm).

Table: degree of flammability of building materials included in st. flammability of substances and products

Degree of flammability	Building materials
A - non-flammable	granite, sandstone, concrete, brick, ceramic tiles, plaster
B - Not easily flammable	Acumin, Heraclitus, Lihnos, Itaver

Degree of flammability	Building materials
C1 - highly flammable	wood, hardwood, plywood, hard paper, umakart
C2 - moderately flammable	chipboards, solodur, cork boards, rubber, flooring
C3 - Highly flammable	wood fiber boards, polystyrene, polyurethane, PVC

- information on the degree of flammability of common building materials is given in the table above. Appliances must be installed in a safe manner. During installation, the relevant design, safety and hygiene regulations must also be respected:
- fire safety of local appliances and heat sources
- fire protection in areas with special risk or danger
- protection against the effects of heat

5. INSTALLATION

Important: The manufacturer does not provide any warranty for defects arising as a result of incorrect use, failure to follow the instructions contained in the attached user manual and mishandling of appliances. Installation, modification and repair of appliances for large kitchens, as well as their dismantling due to possible damage to the gas supply, can only be carried out on the basis of a maintenance contract, this contract can be concluded with an authorized dealer, while technical regulations and standards and regulations must be observed regarding installation, electrical supply, gas connection and work safety. Technical instructions for installation and adjustment, for use by specialized technicians ONLY. The instructions that follow refer to a technician qualified for installation to carry out all operations in the most correct manner and according to the applicable standards. Any activity related to regulation etc. must only be performed with the device disconnected from the network. If it is necessary to keep the appliance under voltage, the utmost care must be taken. The type of appliance for extraction is declared on the nameplate, it is an A1 appliance.

6. WATER CONNECTION

Water connection is done using G1/2 threaded hoses. The water supply must be fitted with separate closures that are freely accessible and within reach of the device. The device includes return valves. The water for filling the duplicator space must be softened - a maximum of 5 ° the French scale of water hardness. The water pressure must be in the range of 50-300 kPa.

7. CONNECTING THE ELECTRICAL CABLE TO THE NETWORK

Installation of the electrical supply - this supply must be separately secured. Ato with the corresponding circuit breaker of rated current depending on the power input of the installed device. Check the power consumption of the device on the production label on the back panel (or side) of the device. The connected ground wire must be longer than the other wires. Connect the device directly to the network, it is necessary to insert a switch between the device and the device with a minimum distance of 3 mm between the individual contacts, which corresponds to the applicable standards and load. The earth supply (yellow-green) must not be interrupted by this switch. Connect the device to the mains if the socket has adequate protection. In any case, the supply cable must be located so that it does not reach a temperature of 50 degrees higher than the environment at any point. Before the appliance is connected to the network, it is necessary to first make sure that:

- the supply circuit breaker and the internal distribution can withstand the current load of the appliance (see matrix label)
- the distribution board is equipped with effective grounding according to the standards of the relevant market and the conditions given by law
- the socket or switch in the supply is easily accessible from the appliance
- the electrical supply to the device must be made of oil-resistant material

We disclaim any responsibility in the event that these standards are not respected and in the event of

a violation of the above principles. Before first use, you must clean the device, see chapter "cleaning and maintenance". The appliance must be grounded using a screw with a grounding mark.

- Do not insert the plug of the power supply into the electrical outlet. sockets and do not pull out the zel. sockets with wet hands and pulling on the power cord!
- Do not use extension cords or multiple sockets.
- **The mains connection point must have a maximum of the following impedance: $Z_{MAX} = 0.042 + j 0.026 \Omega$ for the phase conductors and $0.028 + j 0.017 \Omega$ for the neutral conductor.**







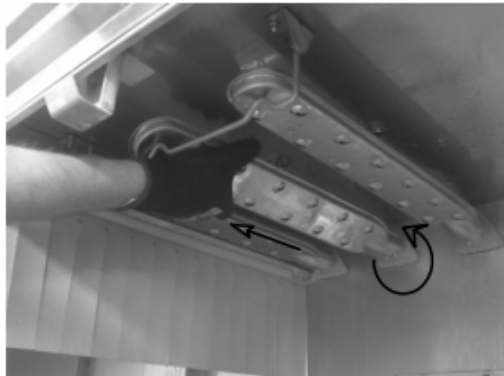
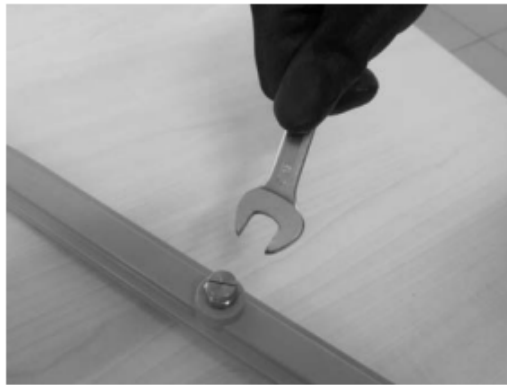
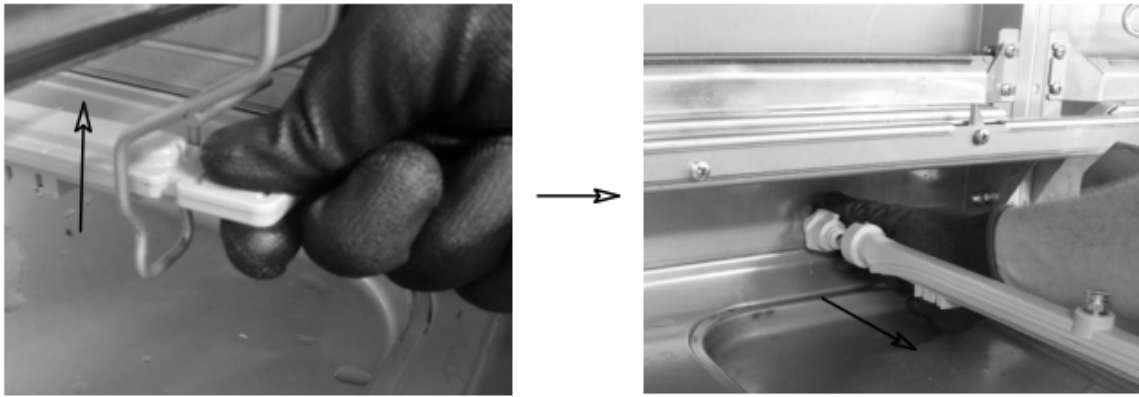

Fig. 9
Fig. 9

Electrical connection

Attention! Installation must only be carried out by specialist technicians!

Before plugging in the machine, make sure that the mains voltage and frequency match the information on the machine's rating plate located on the side panel.

The machine must be connected to the mains by means of a separate multi-pole circuit breaker of the automatic type with fuses and a minimum opening between contacts of 3 mm in accordance with the applicable safety standards. The above-mentioned switch, which was not supplied with the machine, must be installed on the wall in an easily accessible position and at a height of between 0,6 and 1,70 m.

Before connecting to the mains, make sure that there is no voltage in the power line.

Remove the front panel and the protective cover of the electrical box by loosening the screws.

Insert the electrical cable into the cable connector.

Plug the cable into the terminals located in the cabinet as shown in the attached wiring diagram.

In case of incorrect connection of the neutral and ground wire, irreversible damage to the machine and loss of validity of the warranty!

Check the fixing of the contactor cables and thermal protection elements etc., as the screws may become loose during transport.

Reinstall the front cover cable and control panel using the screws provided.

The power cable, type H07RN-F only, must not be stretched or compressed during normal machine operation or routine maintenance.

The device must be integrated into an equipotential system, the connection of which is secured by a screw marked with the symbol .

The equipotential conductor must have a cross section of 10 mm².

It is forbidden to use splitters, adapters, cables of the wrong type or cross-section with extension couplings that do not comply with the applicable standards for machinery.



Connection to the water supply network

Ensure that the installation location is in accordance with the attached installation diagram.

Before connecting the device, make sure that there is no connection between the water supply network and the device a slide gate valve is inserted to allow interruption of the power supply in case of need or repair.

furthermore, make sure that the supply flow is not less than 20 l/min.

Make sure that the temperature and pressure of the feed water corresponds to the information on the technical data plate.

If the water hardness exceeds the table, we recommend that you install a de-scaler before the machine's electrical supply valve.

If there are very high concentrations of high conductivity residual minerals in the water, we recommend that you install demineralization equipment calibrated to achieve the residual hardness shown in the table below.

WARNING, high concentrations of sodium chloride may result in rust.

	Features		Min.	Max.
Hardness	French grades	f	5	10
	German grades	°dH	4	7,5
	English grades	°e	5	9,5
Residual minerals	Parts per million	ppm	70	140
	Maximum	mg/l	300/400	

Connection to the discharge network

Machines with drawn basket are designed to operate continuously, and therefore a particularly efficient discharge head must be provided.

See attached installation diagram for drain hole locations.

Connect the drain holes of the machine to the mains using pipes that are resistant to a constant temperature of 70°C.

Use the drain pipe and the appropriate fitting supplied.

The drainage system must include a siphon.

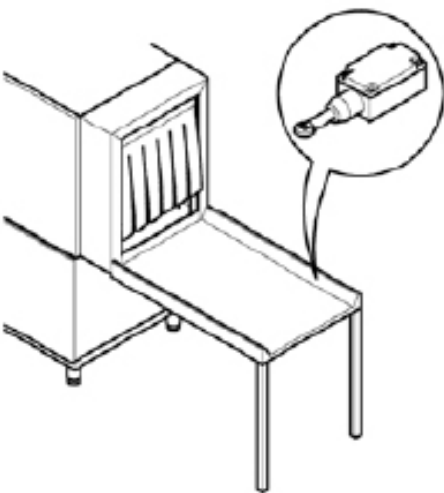

Wiring the limit switch

It is MANDATORY to install a limit switch for the machine to function. The limit switch must be installed on the outlet face.

The mechanical fixing of the switch must be appropriate to its use. We recommend that you use a limit switch with lever and wheel activation to increase the contact surface and reduce the effect of mechanical resistance.

It must be checked for proper operation with all baskets used on the premises.

It shall have protection in accordance with a minimum rating of IP55. The switch must be in positive mode (normally closed NC contact).

Must have a minimum nominal output of 240V 1.5A.

Recommended mechanical durability 10,000 K cycles.

Installation of dispensers

The machine is equipped with special outlets for gloss and detergent dispensers; connect the dosing devices as indicated in the wiring diagram to ensure proper operation of the machine. Dispensing of gloss and detergent must be provided by automatic dispensers.

The quantity of products is determined based on the hardness of the water by the technician in charge of the installation, who also calibrates the dispensers.

For the first filling of the dosing circuit and the corresponding regulation, refer to the paragraph "Regulation".

The level of the liquids in the containers must never drop to the point where they are completely empty.

Products must never be refilled using corrosive or impure products.

It is forbidden to use chlorine-based products that cause the formation of chlorides, as they can cause corrosion at concentrations above 50 ppm

Manual dosing of products is not recommended.

For any other installation, please refer to the attached electrical and installation diagram

The machine is not designed for the installation of multi-voltage dispensers and/or dispensers with an input power exceeding 5 A per output.

If you intend to use this type of dosing device, it must be connected to an external 16 A relay

8. INSTRUCTIONS FOR USE

COMMISSIONING

First filling of the boiler

Image number 2e 6

Open the water filler plug (Fig. 2/A)

Using the main switch, connect the electrical power supply (Fig. 2/B)

The display shows 4 horizontal lines (Fig. 2/C)

To start the machine, press the line button (1) (Fig. 2/D)

The message "FI?" "no" appears alternately on the display (Fig. 6/A)

Press the button (3) to select "yES" (Fig. 6/A)

Confirm by holding down the button (2). (Fig. 6/C)

The machine automatically starts filling the boiler and displays the message "FI" (fig. 6/D)

When the message "LoAd" "End" appears alternately on the display, the filling is complete and the machine is ready to be switched on (Fig. 6/E)

Controls

Check that the water level in the wash tub after filling is 1 - 2 cm below the level at which the overflow protection device intervenes.

Check that the temperature of the washing and rinsing bath reaches the set value

Check the functioning of the dispensers.

Check the correct functioning of the rinse economizer: it must start the hot water supply as soon as the basket gets under the rinse nozzles and must stop it when the basket comes out.

Check the operation of the machine limit switch, which must block the operation of the feed motor and pump when the basket reaches the end of the area. When the basket is removed, operation must be restored.

Check the direction of rotation of the pumps; if they rotate in the opposite direction, switch the phases of the power cable.

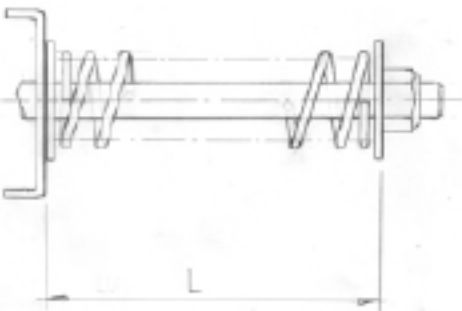

Check the regulation of the mechanical traction safety system, which must be adjusted to the overall length of the machine and the individual output tables.

Even if the baskets are completely filled with dishes, the traction shift must not be blocked.

Adjustment is made by means of a screw located on the bracket that supports the unit for traction movement.

The recommended length "L" must be between a minimum of 60 and a maximum of 75 mm (see picture)

For complex applications, consult the service centre.

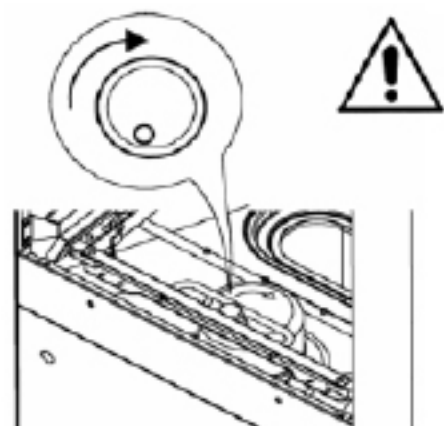

Check that the direction of rotation corresponds to the illustration and markings on the central traction movement.

WARNING: if the rotation direction is incorrect, the mechanical safety feature will not function.

Check the pressure gauge during rinsing. If necessary, use the pressure regulator to adjust the value shown in the table:

View Full Version	Litres / hour.	bar	
Without pre-washing	160	0,6	
With the pre-wash	270	0,7	

Failure to carry out these checks will automatically invalidate the warranty.

AFTER INSTALLATION IS COMPLETE

The installation technician must inform the manufacturer of any malfunctions or safety problems that occur during the first test run.

The machine can only be used after the installation is complete.

The engineer must issue a statement that the work has been carried out "according to best practice" and in accordance with applicable laws.

Diagram of the machine



- 1 Pre-wash chamber
- 2 Washing chamber
- 3 Pre-rinse chamber
- 4 First rinse chamber
- 5 Final rinse chamber
- 6 Drying chamber
- 7 Steam extraction and recovery area
- 8 Prewashing bath
- 9 Wash tub
- 10 Rinse tub
- 11 Boiler

Machines with a trailing basket are constructed using high quality materials, the washing tubs are made of aISI 304 stainless steel and other components made of common stainless steel.

The first coarse washing of the dishes takes place in pre-wash sector 1.

The dishes are washed in washing sector 2.

In sectors 3, 4, 5, rinsing takes place.

In sector 6 the dishes are dried.

In sector 7, steam extraction or heat recovery takes place.

The dragging of the baskets through the individual sections is done automatically by lateral traction.

Dangerous places

One of the dangerous places or areas of the machine is the zone where fires can occur if the instructions below are not followed.

If traction is blocked during normal operation, press the line button. Restart the machine only after you

have detected and corrected the cause of the blockage.

It is forbidden and very dangerous to enter the machine at the traction input and output when the machine is switched on and in motion.

It is forbidden and very dangerous to repair the traction system and electrical appliances when the machine is running.

It is forbidden to use the machine without supervision by an operator.

Do not immerse your hands in the water contained in the tubs.

It is forbidden to approach the switch to deactivate or activate the machine with wet hands.

It is strictly forbidden to enter the electrical cabinet.

Safety equipment

Magnetic switches are mounted on the doors, which interrupt the pre-wash, wash, rinse and basket traction cycle if they are opened.

Protection against accidental start-up. In the event that the machine stops suddenly due to a power failure, its functions will not be automatically restored when the power supply is restored.

Thermal protection elements for electric pumps and motors to protect them from damage in the event of short circuits and overloads.

Thermal protection elements and/or fuses for each heating element to ensure protection against short circuits and overloads.

Boiler safety thermostat. In the event of a failure of the temperature control thermostat, a second safety thermostat intervenes to interrupt the operation of the heating elements.

Safety micro switch for traction. If the traction is suddenly blocked, the micro switch located near the electric gearbox support will interrupt the towing.

Safety door stop. In the event that the spring breaks when the door is opened, the hooks prevent it from falling.

Low voltage controls.

Use in accordance with regulations

Machines with a trailing basket have been specifically designed to wash plates, glasses, cups, cutlery etc. together with the basket in which they are inserted. Any other use is considered improper.

The manufacturer's safety, work and maintenance instructions must be followed.

The relevant accident prevention regulations and recognised technical safety regulations must be complied with.

The machine must only be used by persons who have been properly informed of the possible risks.

The machine may only be used with original accessories and spare parts supplied by the manufacturer.

USE OF THE MACHINE

Description of controls

1	ON/OFF BUTTON	5	INFORMATION DISPLAY
2	START/STOP BUTTON	6	FUNCTION BAR (LED)
3	BUTTON FOR SELECTING PROGRAMS	7	ALARM BAR (LED)
4	BUTTON FOR SELECTING PROGRAMMES		

Switching on the machine

Picture number 2

Open the water filler plug (Fig. 2/A)

Using the main switch, connect the electrical power supply (Fig. 2/B)

The display shows 4 horizontal lines (Fig. 2/C)

To start the machine, press the line button (1) (Fig. 2/D)

The flashing "FILL" appears on the display and the machine starts filling water (Fig. 2/E)

When the correct level is reached, the message "SP2" appears on the display as standard (Fig. 2/G)

Heating

Picture number 2

After filling, the machine automatically starts heating

During heating, the LED function bar (6) flashes orange (Fig. 2/G)

When the set temperatures are reached, the LED function bar (6) stops flashing and turns green (Fig. 2/H)

Washing

Picture number 4

To start washing, simply insert the basket into the machine inlet so that the basket dragging system is activated.

The LED function bar (6) will gradually flash.

During washing, the display shows the current washing programme

Washing programmes

The following programs can be selected from the keypad:

standard programs that can be selected by pressing the button (4)

SP1 "Hight capacity", designed to wash lightly soiled dishes without dried-on dirt.

SP2 "General purpose", a general purpose program.

advanced programs that can be selected by pressing the button (3)

AP1 "prolonged contact" ensures washing time in accordance with DIN 10534

AP2 "Glass" programme specially designed for washing glasses.

Press the button (2) to select a different programme during washing.

Stopping device

The machine is equipped with a line ON/OFF button (1) located on the control panel. Pressing it will immediately stop all moving organs and the washing program.

Additional optional stopping devices can be installed near the inlet and outlet of the baskets.

Temperature and operating hours display

The wash and rinse temperature can be displayed at any time.

Just hold down the button (2) for a few seconds.

The display shows the washing temperature "t", the rinsing temperature "b" and the number of operating hours of the machine "Hr".

The message will be displayed twice.

Limit switch

The machine must operate with the limit switch installed on the outlet face of the baskets (see installation section).

The message "End" appears on the display when the basket reaches the end of the area after leaving the machine and traction is

stops just long enough to prevent the basket from being removed (Fig. 3)

To fully restart the machine, simply remove the basket from the end of the surface.

If the basket is not removed within a few minutes, the machine will gradually shut down the rinsing, washing, pre-washing area and finally the drying area, if installed.

Regulation

The user can control the temperature and dosing times.

With reference to Figure 7

- Switch off the machine by pressing the line button (1) (Fig. 7/A)
- Open the machine door (fig. 7/B)
- The message "door" appears on the display (Fig. 7/C)
- Hold down the buttons (1) and (2) simultaneously for a few seconds (Fig. 7/D)
- The display alternately shows the message "CH" "0".
- Use the buttons (3) and (4) to scroll to and select the number "12" (Fig. 7/E)
- Press the line button (1). (Fig. 7/F)
- Select the parameter you wish to edit. Use buttons (1) and (2) to scroll through the list (Fig. 7/G)
- The parameter and the set value will be displayed successively on the display (fig. 7/H)
- Use the buttons (3) and (4) to set the desired value (Fig. 7/I)
- After all adjustments have been made, hold the line button (1) for a few seconds
- The new settings are now saved and the message "-----" appears on the display (Fig. 7/M)

temperatures

All washing programmes can be set to wash and rinse temperatures except for the "Glass" programme

Parameter	Program rinse temperature	control range (°C)
b1	"SP1"	"oFF",1,2...90
b2	"SP2"	
b3	"AP1"	
Parameter	Washing programme temperature	control range (°C)

t1	"SP1"	"oFF",1,2...70
t2	"SP2"	
t2	"AP1"	

dispensers

It is possible to set the dosing time of the gloss and detergent dispensers in seconds

Parameter	Dosage time	control range (s.)
dt	cleaning agent	oFF,1,2...25
bL	gloss	oFF,1,2...25

The dosing circuit can be filled manually.

Proceed as follows:

- If you wish to fill the polish circuit, select the "bn" parameter in the menu, if you wish to fill the detergent circuit, select the "dn" parameter.
- If the gloss circuit is selected, the display will sequentially show "bn", "oFF" , if the detergent circuit is selected, the sequence "dn", "oFF" will be shown.
- Hold the button (3)
- The respective dosing device starts filling the circuit and the display shows "on" instead of "oFF"
- To stop the dispenser, simply release the button (3).

Messages for users

Display	Message description
door	door open
b	rinse water temperature
t	temperature of the washing water
FI	activation of the first filling
FILL	Filling the bath
nodt	Lack of cleaning agent
nobL	Lack of gloss
Fu A	firmware revision
C5	software code
Hr	number of operating hours
End	Limit switch intervention

Function bar and status bar

The machine is equipped with coloured LED lights that instantly display the status and functions of the machine in real time.

FUNCTION BAR (LED)

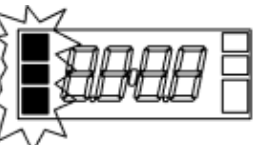
	Green	No alarm
	Orange	Alarm that indicates malfunction but does not stop the machine
	Red	Alarm that blocks the machine from functioning
ALARM BAR (LED)		
	Green lights	The machine has reached the set temperature and is ready for use
	Green flashing	Washing activated
	Orange flashing	Heating in progress

AUTODIAGNOSTICS

The appliance is equipped with a self-diagnostic system and is capable of detecting and signalling a wide range of faults.

Failure	Description and possible solutions
Er01	No rinse. The surface rinse did not take place correctly. Check that the rinse nozzles are clean.
Er02	No water was released. The water is not draining, or it's not draining properly. Check to see if the drain hose is bent or not properly connected, or if the siphon or filters are clogged. For appliances equipped with an overflow, the overflow must be removed before starting the drain cycle.
Er03	Failure to restore rinse temperature. Heater temperature reset did not occur at the predetermined time during the wash cycle. Turn the appliance off and then back on and perform a new cycle.
Er04	Failure of water filling into the tank. Make sure all water connections are well connected and the tap is open. If there is an overflow in the dishwasher, check that it is in place. Turn the appliance off, then back on, and try filling it again.
Er05	Tank thermometer malfunction. (Sensor disconnected) The appliance does not detect the temperature value in the tank. Switch the appliance off and then on again.
Er06	Tank thermometer malfunction (sensor short circuit) The appliance does not detect the temperature value in the tank. Switch the appliance off and then on again.
Er07	Boiler thermometer malfunction. (Sensor disconnected) The appliance does not detect the boiler temperature value. Switch the appliance off and then on again.
Er08	Boiler thermometer malfunction. (Sensor short circuit) The appliance does not detect the boiler temperature value. Switch the appliance off and then on again.
Er09	Boiler filling time delay: the boiler is not filling. It is not possible to rinse. Check that the tap is open. Switch the appliance off, then on again, and carry out a new cycle.
Er21	Rinsing insufficient, rinsing not done in the right quantity. Check that the rinsing nozzles have been cleaned correctly. The appliance does not stop when an error is reported.
Er22	Tank temperature reset failure: the tank temperature reset did not occur at a predetermined time during the wash cycle. Turn the appliance off and then back on and perform a new cycle.
Er25	Performing external regeneration: the number of litres set for the external water treatment device has been reached, the error does not hinder the operation of the dishwasher, the message can be removed in menu setting 12.
ErSF	Electromechanical protection: the safety thermostats of the boiler or tank have been affected or the safety pressure switch for the tank level has been affected.
ErSL	Securing the level: Incorrect water level in the bathtub.
Coat of arms	Excessive boiler temperature: probable heating relay/ contactor failure.
Ert	Excessive tank temperature: probable failure of the relay/heater contactor.
drt	Clogged filter: improper water level in the bathtub caused by a dirty filter or an improperly inserted overflow.

Failure	Description and possible solutions
ErSI	Input Security Error: Irreversible error, contact Technical Assistance.
Er98	Soft start, I think: Error in the soft start system, contact Technical Assistance.
NO SALT	Lack of salt: in dishwashers with a softener, this indicates a lack of salt. Add salt.

NO DT	Lack of cleaning agent: Add detergent to the filling tank.
NO BL	Lack of polish: Add polish to the filling tank.
SERV	Maintenance Requirement: Routine maintenance is required if preset.
REG ON	Regeneration in progress: the water softener resin regeneration cycle is in progress.
REG REQ	Regeneration requirement: regeneration must be running if it is not automatically scheduled.
Er27	Boiler gradient error: the boiler heating is not working properly.
Er28	Tank gradient error: tank heating is not working properly.
Er99	Auxiliary card error: communication with the auxiliary card is not working properly.
Er30	Auto-opening error: on hood washers with automatic opening, the opening system is not working properly. Make sure that there is nothing obstructing the opening of the bonnet. If the problem persists, call a service centre.
Er31	Auto-close mode: on hood washers with automatic opening, the closing system does not work properly. Make sure that nothing obstructs the closing of the bonnet. If the problem persists, call a service centre.
Er33	Osmosis with minimum pressure: Make sure the water tap is open.
Er34	Osmosis water leak: close the electricity and water supply to the dishwasher, contact technical support.
Er35	Osmosis conductivity error: the system is not working properly, contact technical support.
Er36	Osmosis filter: the osmosis filter needs to be replaced, contact technical support.
Er37	Boiler heating timeout: the rinse water heater is not working properly, contact technical support.
Er38	Tank heating time limit: The wash water heating element is not working properly, contact technical support.
Er39	Boiler pressure switch failure.
Er40	Failure of the tank pressure switch.
Switching the appliance off and then on will "reset" the alarm; if the problem persists after following these instructions, contact an authorised service centre.	

actions after washing

With reference to Figure 8

- Switch off the machine using the line button (Fig. 8/A).
- Switch off the main wall switch (Fig. 8/B)
- Open the door and make sure it is securely fastened to the appropriate supports (Fig. 8/C)
- Remove the horizontal filters, being careful not to let food debris fall into the wash tub. (Fig. 8/D)
- Lift the vertical tray filter and empty its contents. Using a hard brush, clean both the horizontal filters and the tray filter (Fig. 8/D)
- Remove the overflow protection device and allow the bath to empty (Fig. 8/F)
- Carefully wash the bottom of the tub with a stream of running water.
- Wash the flaps carefully.
- After emptying the tub, remove any small dirt residues. Only now remove the pump safety filter and wash it under running water (Fig. 8/G)
- The external parts of the machine should only be cleaned after the surfaces have cooled down. Use a sponge and non-foaming, non-acidic and non-abrasive products.
- Reinsert the overflow protection device, filters and tray.

The machine is now ready for use.

ATTENTION: Do not wash the machine with direct streams of water or under high pressure, as water could enter the electrical components if the proper functioning of the machine and safety systems could be compromised, which would void the warranty.

We recommend that you leave the door open to avoid odours.

Arrangement of dishes

With reference to Figure 5

- Place the cups and glasses in the baskets, bottom up.
- Place the plates in the appropriate basket equipped with support elements so that the inner surface faces upwards.
- Place the cutlery and coffee spoons in the appropriate basket with the handle facing downwards.

Recommendation:

- Do not put silver and stainless steel cutlery in the same cutlery basket, this will brown the silver and possibly corrode the stainless steel.
- For different types of utensils (plates, glasses, cups, cutlery, etc.), use special baskets designed for them.
- In order to save detergent and electricity, always fill the bins fully without overfilling them.
- Do not place dishes over each other.
- In order to keep maintenance to a minimum, we recommend cleaning the dishes beforehand and removing food debris, lemon peel, toothpicks, olive pits, etc, which could partially clog the electric pump filter and reduce the washing efficiency and the quality of the end result.
- We recommend that you wash the dishes before the food residue dries on the surface. In case of dried-on dirt, it is advisable to let the dishes and cutlery soak before putting them in the machine.

mAINTENANCE

The machines are designed to require minimal maintenance. In order to achieve a long and trouble-free service life and functionality, all of the following instructions must be followed.

In any case, some general rules must be followed in order to keep the machine in perfect working order:

- keep the machine clean and tidy
- prevent temporary or urgent repairs from becoming frequent

Strict adherence to regular maintenance instructions is extremely important; all machine organs must be checked regularly to prevent breakdowns, and a time period must be set for any maintenance that may be required.

Disconnect the power supply to the machine before cleaning.

Regular maintenance

With reference to Figure 9

Remove the upper and lower rinsing arms.

- Clean any nozzles that are clogged and reinstall them in place.
- Remove the hinges and clean them under a stream of water using a nylon brush.
- Remove the upper and lower rinsing arms, clean and rinse them.
- Remove the wash pump filter, clean and rinse it.
- Then very carefully clean the wash tub.

- Due to the presence of calcium and magnesium salts in the water, after a certain period of use, which depends on the hardness of the water, limescale deposits begin to form on the internal surfaces of the boiler sump and pipework, which can compromise the good functioning of the machine.
- Therefore, limescale must be removed regularly. We recommend that this is carried out by qualified technicians.
- If the equipment is left unused for a long period of time, apply petroleum jelly to the steel surfaces.
- If there is a risk of freezing, ensure that a qualified engineer drains the water from the boiler and wash pump.
- If limescale deposits form inside the machine due to the water content, they can be removed with a suitable descaling product.
- When descaling, strictly follow the product manufacturer's instructions or consult qualified personnel. In any case, rinse the machine well after descaling.
- Check the effectiveness of the safety devices.
- If the steam condensing battery is dirty, dismantle it and clean it with compressed air.

9. CLEANING AND MAINTENANCE

It is recommended to have the device checked with a specialist service at least once a year. All the interventions in the device can only be carried out by a qualified person who has the authorization to do so.

CAUTION! The device must not be cleaned with direct or pressure water. Clean the equipment daily. Daily maintenance extends the life and efficiency of the equipment. Always turn off the main inlet to the device. Wash the stainless steel parts with a damp cloth with a detergent without coarse particles and wipe dry. Do not use abrasive or corrosive cleaning agents. Attention! Before using the device, it is necessary to remove the protective foil from the entire surface, and then wash it well with water with detergent, and then wipe it with a damp cloth. **ALERT!** The warranty does not apply to all consumables subject to normal wear (rubber seals, bulbs, glass and plastic parts, etc.). The warranty also does not apply to the device if the installation is not carried out in accordance with the instructions - an authorized worker according to the corresponding standards and if the equipment was unprofessionally manipulated (interventions in the internal equipment, etc.) or were operated by unhappy staff and contrary to the instructions for use, further The warranty does not apply to damage by natural effects or other external intervention. **Required service organization 2 times a year. After the lifetime, the shipping packaging and equipment are submitted to the collection, according to the regulations on waste management and hazardous waste.**